

PCE data sheet

article#	223-10
article description	CEE-connector 32A 3p 10h IP44/IP54 SHARK
description long	CEE-connector 32A 3p 10h IP44/IP54 SHARK housing material: PA6 rated current: 32A number of poles: 3 (2P+PE) clock-position: 10h rated voltage/frequency: >50V~ / 100-300Hz contacts: brass connection technology: screw terminals IP protection class: IP44/IP54
GTIN (EAN)	9003399151125
country of origin	AT
customs number	85366990
net weight	0.228 kg
packaging quantity	10
minimum order quantity	10

ETIM 7.0	EC001320
IEC-amperage	32 A
Number of poles	3
Voltage acc. EN 60309-2	50-500 V (100-300 Hz) green
Clock hour position	10 h
Identification colour	Green
Degree of protection (IP)	IP44
Connection system	Screwed terminal
Angle of plug	Straight
Cable entry	Swivel
Material	Plastic
Contact material	CuZn
Surface finish contacts	Untreated

a	161 mm
b	94 mm
K (cable Ø)	11,5-20 mm
SW	50 mm
wire flexible	2,5-6 mm ²
contact screws	110 Ncm
strain relief	600 Ncm
dismantling length	50 mm
stripping length	12-14 mm

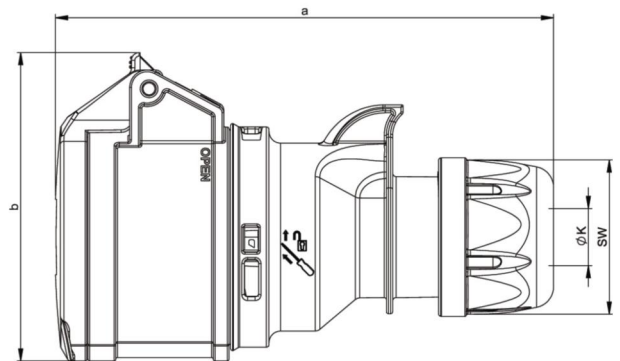

www.manufacturer-safety.info